

Wall sconce SPHERE

7025N/2

Wall sconce

Wall sconce with glass ball of the [SPHERE collection](#) 7025N/2. Modern [light fixture](#) designed and produced in Athens, Greece by [MAVROS Lighting](#).

Specifications

Brand : MAVROS

Style : Modern

Frame

Material : Iron

Color : Black

Glass

Material : Opal

Color : White

Electrical parts

Lamp Holder : E14

LED light Bulbs : 2 x max 40 Watt

Packaging

Net weight : 1.3kg

Details

Slight deviations in size or colour are likely to occur.

Certificates



Light diagram



Energy diagram

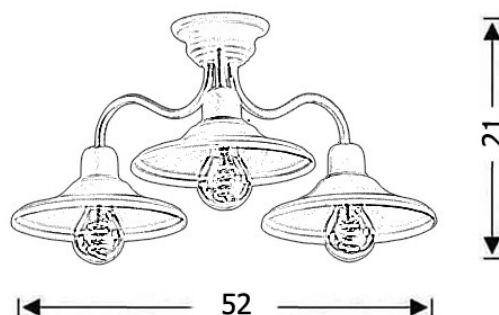
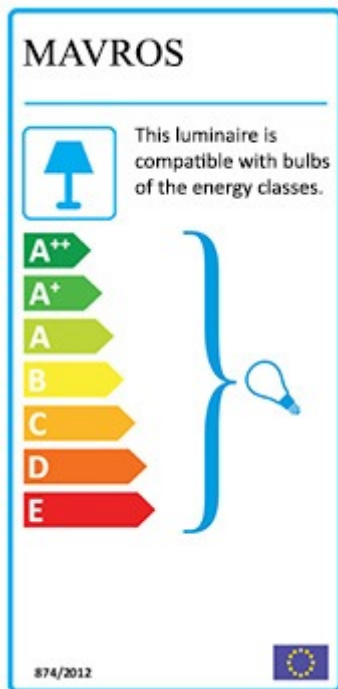

Handmade ceiling lamp IOS

8026CO/20/3

Handmade ceiling lamp

Graphite handmade rustic ceiling lamp of the [IOS collection](#) 8026CO/20/3. Retro [ceiling lamp](#) designed and produced in Athens, Greece by [MAVROS Lighting](#).

Specifications

Brand : MAVROS

Style : Vintage

Frame

Material : Iron

Color : Graphite

Electrical parts

Lamp Holder : E27

LED light Bulbs : 3 x max 60 Watt

Packaging

Net weight : 1.1kg

Details

Slight deviations in size or colour are likely to occur.

Certificates



Light diagram



Energy diagram

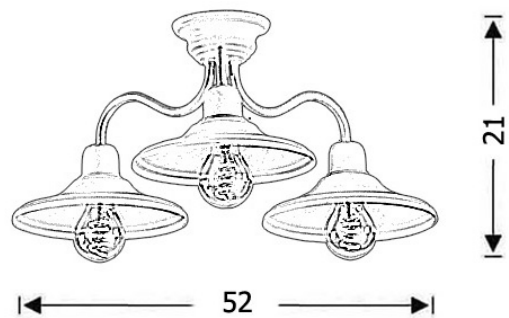
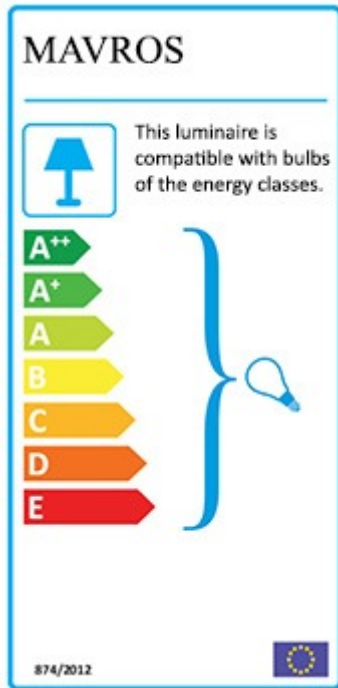

Rustic ceiling lamp IOS

8026CO/20/3

Rustic ceiling lamp

Brown rust rustic ceiling lamp of the [IOS collection](#) 8026CO/20/3. Retro [ceiling lamp](#) designed and produced in Athens, Greece by [MAVROS Lighting](#).

Specifications

Brand : MAVROS

Style : Vintage

Frame

Material : Iron

Color : Brown rust

Electrical parts

Lamp Holder : E27

LED light Bulbs : 3 x max 60 Watt

Packaging

Net weight : 1.1kg

Details

Slight deviations in size or colour are likely to occur.

Certificates



Light diagram



Energy diagram

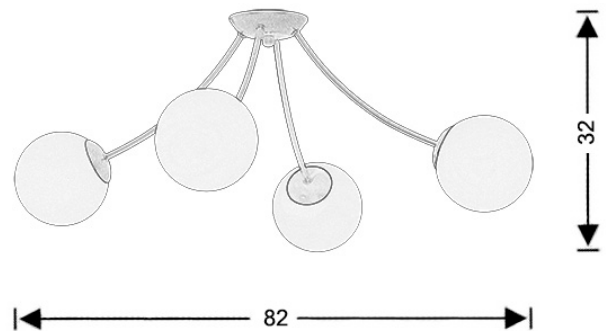
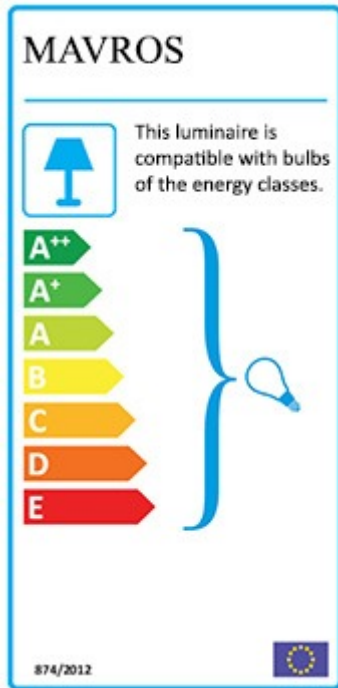

Modern hanging ceiling lamp SPHERE

8025V/4

Modern hanging ceiling lamp

Modern hanging ceiling lamp of the [SPHERE collection](#) 8025V/4. [Light fixture](#) designed and produced in Athens, Greece by [MAVROS Lighting](#).

Specifications

Brand : MAVROS

Style : Modern

Frame

Material : Iron

Color : Bordeaux

Glass

Material : Opal

Color : White

Electrical parts

Lamp Holder : E14

LED light Bulbs : 4 x max 40 Watt

Packaging

Net weight : 2kg

Details

Slight deviations in size or colour are likely to occur.

Certificates



Light diagram



Energy diagram

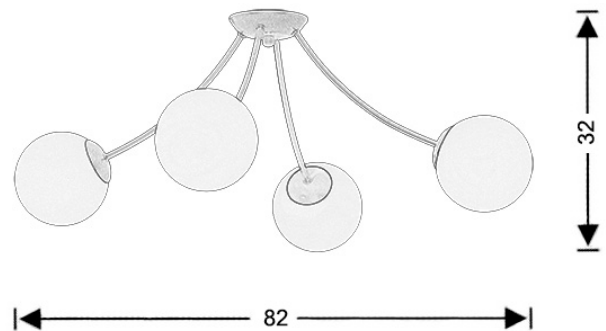
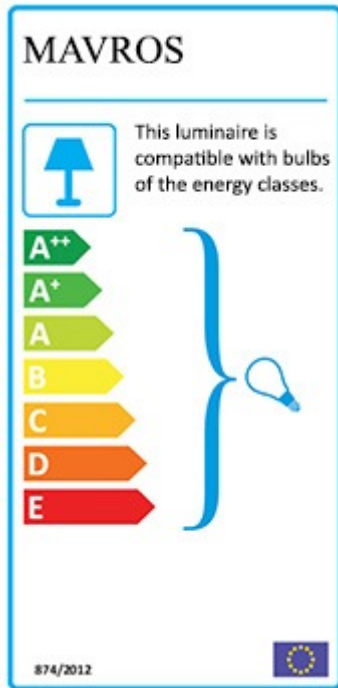

Hanging ceiling lamp SPHERE

8025V/4

Hanging ceiling lamp

Hanging ceiling lamp with glass balls of the [SPHERE collection](#) 8025V/4. Modern [light fixture](#) designed and produced in Athens, Greece by [MAVROS Lighting](#).

Specifications

Brand : MAVROS

Style : Modern

Frame

Material : Iron

Color : Gold (Powder paint)

Glass

Material : Opal

Color : White

Electrical parts

Lamp Holder : E14

LED light Bulbs : 4 x max 40 Watt

Packaging

Net weight : 2kg

Details

Slight deviations in size or colour are likely to occur.

Certificates



Light diagram



Energy diagram

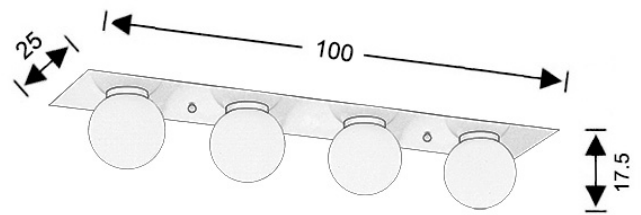
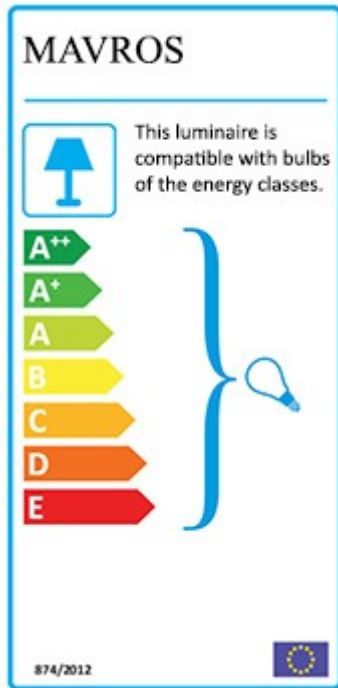

Black & white ceiling lamp SPHERE

8025/10025/15/BI

Black & white ceiling lamp

Black & white ceiling lamp with glass balls of the [SPHERE collection](#) 8025/10025/15/BI. Modern [light fixture](#) designed and produced in Athens, Greece by [MAVROS Lighting](#).

Specifications

Brand : MAVROS

Style : Modern

Frame

Material : Iron

Color : White, Black

Glass

Material : Opal

Color : White

Electrical parts

Lamp Holder : E14

LED light Bulbs : 4 x max 40 Watt

Packaging

Net weight : 4.4kg

Details

Slight deviations in size or colour are likely to occur.

Certificates



Light diagram



Energy diagram

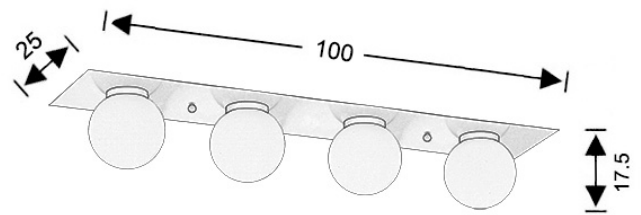
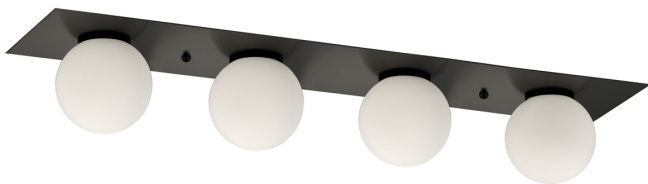
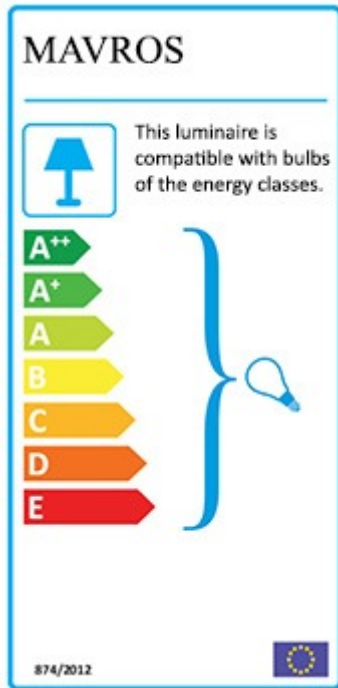

Large ceiling lamp SPHERE

8025/10025/15

Large ceiling lamp

Large ceiling lamp with glass balls of the [SPHERE collection](#) 8025/10025/15. Modern [light fixture](#) designed and produced in Athens, Greece by [MAVROS Lighting](#).

Specifications

Brand : MAVROS

Style : Modern

Frame

Material : Iron

Color : Black

Glass

Material : Opal

Color : White

Electrical parts

Lamp Holder : E14

LED light Bulbs : 4 x max 40 Watt

Packaging

Net weight : 4.4kg

Details

Slight deviations in size or colour are likely to occur.

Certificates



Light diagram



Energy diagram

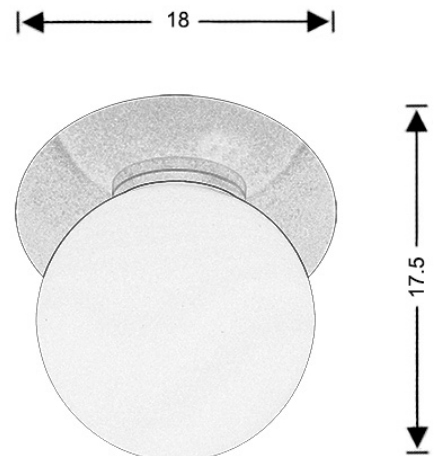
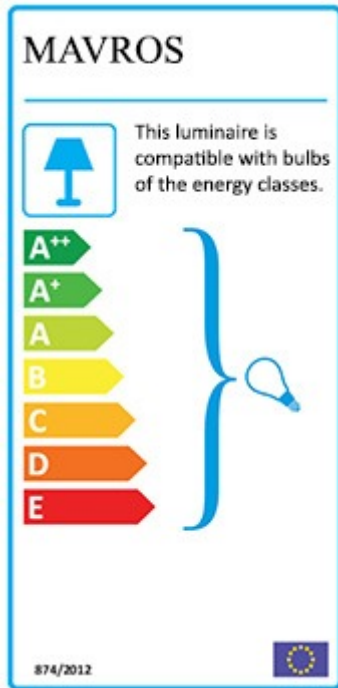

Small modern light fixture SPHERE

8025/18C

Small modern light fixture

Small modern light fixture with glass ball of the [SPHERE collection](#) 8025/18C. Modern [light fixture](#) designed and produced in Athens, Greece by [MAVROS Lighting](#).

Specifications

Brand : MAVROS

Style : Modern

Frame

Material : Iron

Color : Silver (Powder paint)

Glass

Material : Opal

Color : White

Electrical parts

Lamp Holder : E14

LED light Bulbs : 1 x max 40 Watt

Packaging

Net weight : 1.1kg

Details

Slight deviations in size or colour are likely to occur.

Certificates



Light diagram



Energy diagram

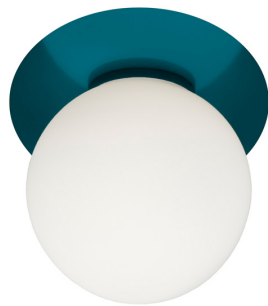
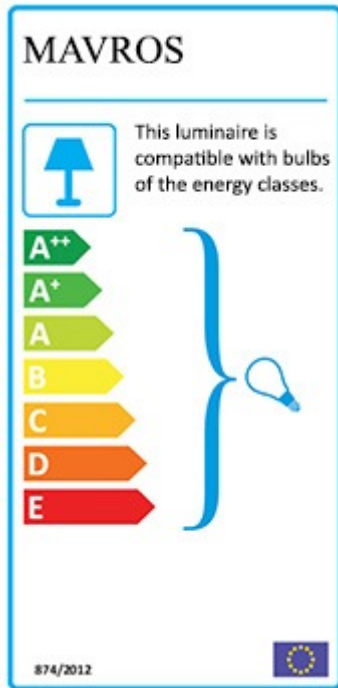

18

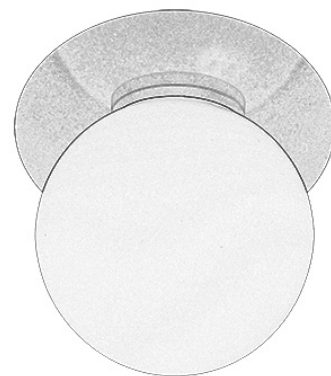

17.5

Modern light fixture SPHERE

8025/18C

Modern light fixture

Modern light fixture with glass ball of the [SPHERE collection](#) 8025/18C. Modern [light fixture](#) designed and produced in Athens, Greece by [MAVROS Lighting](#).

Specifications

Brand : MAVROS

Style : Modern

Frame

Material : Iron

Color : Green, Blue

Glass

Material : Opal

Color : White

Electrical parts

Lamp Holder : E14

LED light Bulbs : 1 x max 40 Watt

Packaging

Net weight : 1.1kg

Details

Slight deviations in size or colour are likely to occur.

Certificates



Light diagram



Energy diagram

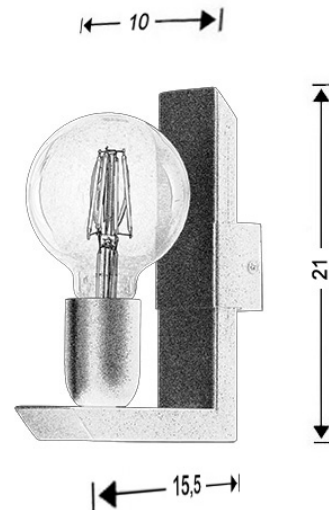
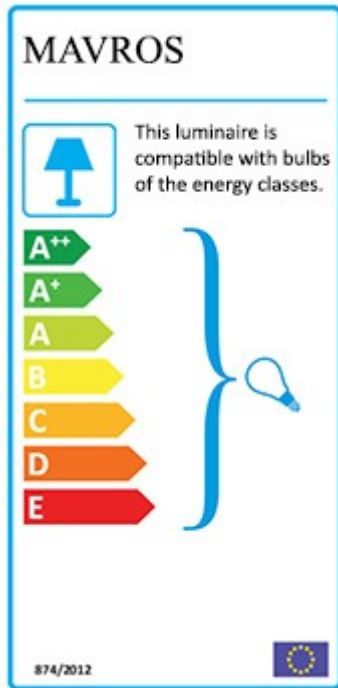

Wall sconce THASSOS

7034

Wall sconce

Wall sconce in brown rust of the [THASSOS collection](#) 7034. Vintage [wall lamp](#) designed and produced in Athens, Greece by [MAVROS Lighting](#).

Specifications

Brand : MAVROS

Style : Vintage

Frame

Material : Iron

Color : Brown rust

Electrical parts

Lamp Holder : E27

LED light Bulbs : 1 x max 60 Watt

Packaging

Net weight : 1kg

Details

Slight deviations in size or colour are likely to occur.

Certificates



Light diagram



Energy diagram

MAVROS



This luminaire is compatible with bulbs of the energy classes.

A⁺⁺

A⁺

A

B

C

D

E



874/2012

